



Primescan Connect™: Easy scan, seamless collaboration

A fast and accurate intraoral scanner, now in a laptop configuration

[Learn more >](#)





Digital impressions are fast, accurate and more comfortable

A simple scan is all it takes

Primescan® is an intraoral scanner that allows you to perform high-precision digital impressions of the patient's mouth, without the use of conventional impression material.

Better results for you, better outcomes for your patients

Digital impressions are transforming the dental practice by:

- Helping to optimize diagnostics and treatment planning
- Supporting financial growth
- Enabling the delivery of high-quality patient care

Primescan helps to increase patient comfort and fitting accuracy

80%

of patients feel more confident that they are getting excellent dental care when you choose digital technology such as an intraoral scanner.¹



1. US Patient Survey, May 2020, N=254 US Adult Dental Patients.

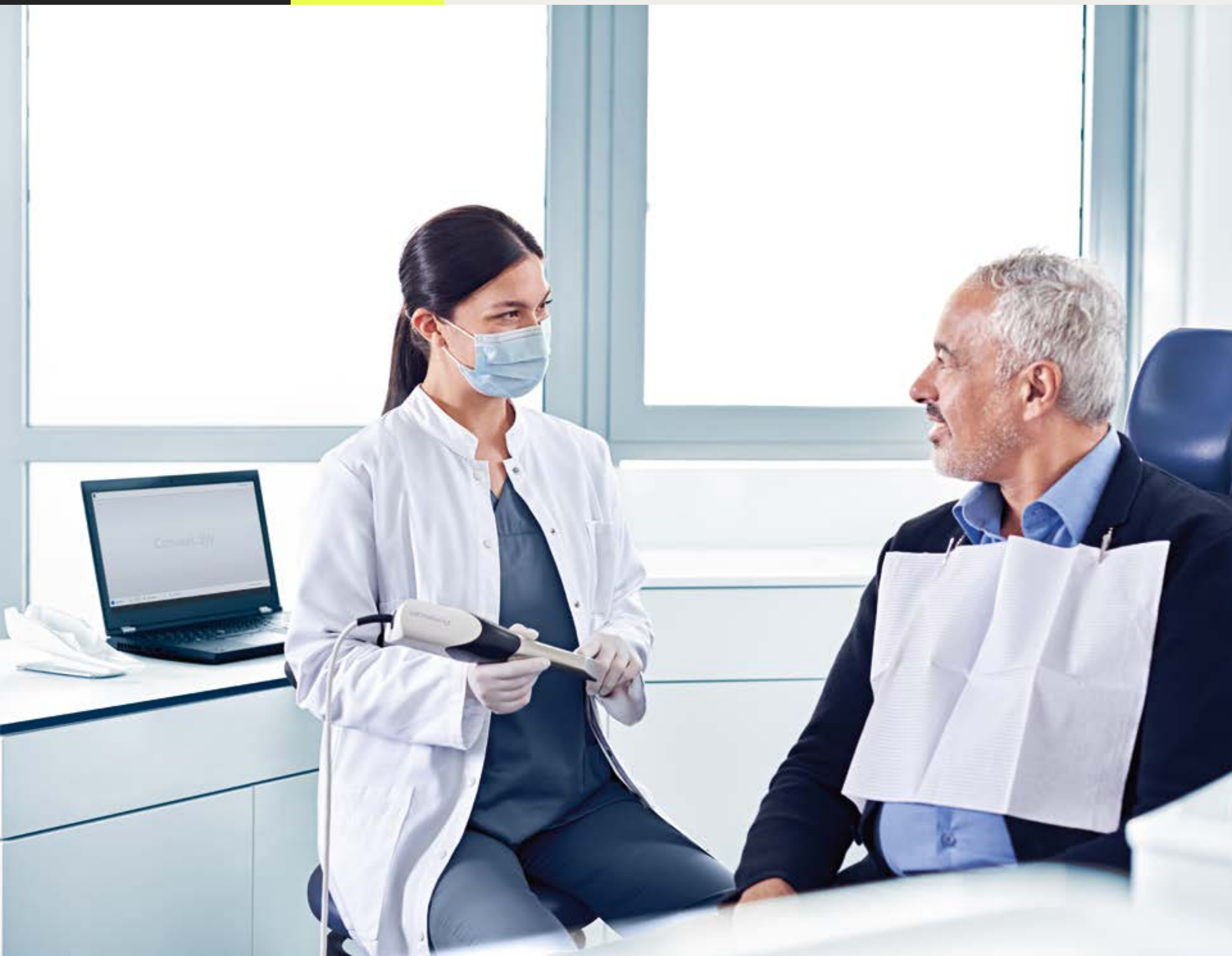

Primescan Connect offers high performance at an accessible price.

Primescan's accuracy has been proven in several studies. For more detail, please refer to the [Dentsply Sirona Clinical Study Overview](#)

Primescan Connect: the easy way to start

All the benefits of Primescan are now available in an accessible solution, making it an easy starting point in digital dentistry. Introducing **Primescan Connect**: a fast and accurate intraoral scanner that comes in a laptop configuration. Primescan Connect is easy to use, adopt and delegate. Plus, the laptop is included, so you can start scanning right away.

Everything you need to get started in digital dentistry

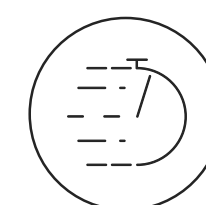

Speed¹

Full arch scan in less than a minute

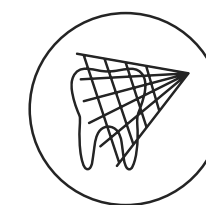

Accuracy

Excellent scans no matter which material or how difficult it is to capture the area



Ease of Use

Helps to simplify the scanning process, so you can delegate and spend more time with your patients



Connectivity

Powered by DS Core™, so you can share intraoral scans together with other case files to collaborate seamlessly with lab partners and colleagues

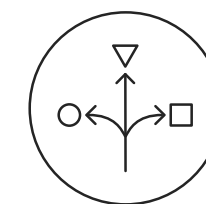

Flexibility

Takes up only a little space and is easy to integrate into any workflow and practice set-up

1. From Connect SW 5.2. Internal data on file.

Enjoy the scan with our latest technology

Primescan Connect completes a full arch scan in **less than 1 minute**, which means more comfort for your patients.

- Future-proof patented technology
- Easy scanning of deep cavities and steep inclines
- Simple scanning of large edentulous areas and palates
- Smooth scanning of reflective materials, like metal crowns, meaning no limitations in case selection
- Unique three sleeve concept and a variety of cleaning and disinfection options, exceeding the minimum recommended hygiene guidelines
- Fully closed scanning window to prevent liquid infiltration during the scanning process

Engineered for a very high level of performance



[Click on the device feature to learn more](#)

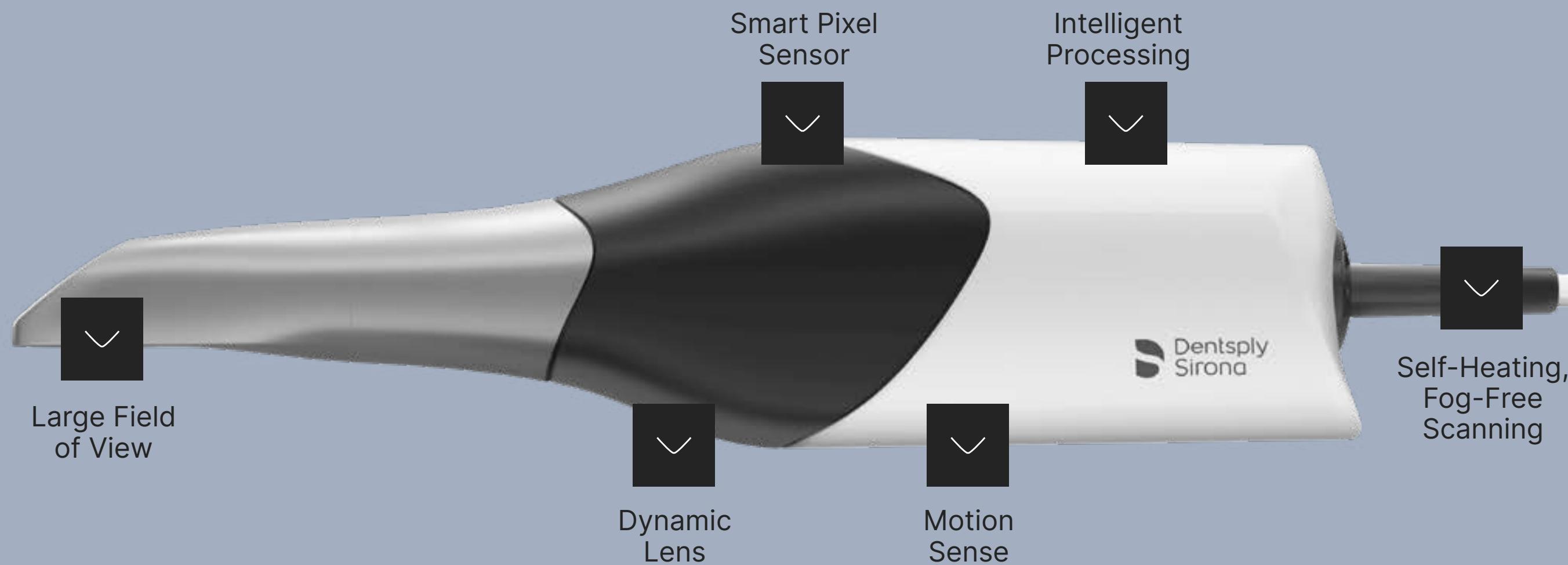

With three different sleeves, you can easily integrate the intraoral scanner into your hygiene concept

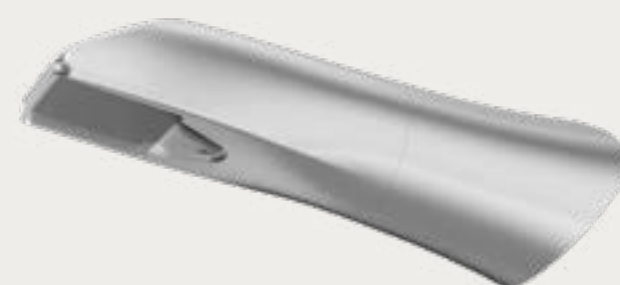

Autoclavable steel sleeve with single-use window.



Disposable sleeve meeting hygiene requirements to prevent cross-contamination.



Steel sleeve with sapphire glass window that can be sterilized with dry heat or treated with high-level disinfection (HLD).



Provide an excellent treatment experience

What dentists and patients think

“My case acceptance has gone up tremendously and anxiety is not an issue anymore. Patients can see what I see. When I show them where the crack is, where the missing filling is, that builds that trust factor much easier, much better.”

Dr. Isaa Bina, USA

“Coming to Dr. Bina has been life-changing because I went from being really scared and anxious to now being open to any procedure actually.”

Patient

Benefits for your patients



Enhance patient experience

Provide your patients with a fast and comfortable treatment experience.



Educate your patients

Share information with your patients to help them decide on the treatment possibilities.

Benefits for you and your practice



Increase case acceptance

Offer a better patient experience to increase treatment acceptance and thus, profitability.



Enhance your practice image

Stay competitive in the market by setting apart your practice.





Work more efficiently with DS Core¹

Get the most out of your Primescan Connect with Dentsply Sirona's cloud-based solution: **DS Core**.

DS Core is a digital platform that offers cloud storage and patient file-sharing tools. It provides you with a comprehensive patient media library where all intraoral scans and other case-related files can be stored and easily accessed, to make your workflows more efficient.

- Comprehensive patient media library for very efficient workflows and treatment planning
- Up to 15TB of cloud storage and unlimited file-sharing with lab partners and colleagues
- Supports GDPR/HIPAA-compliant collaboration and privacy of your patient's data
- Accessible via web browser both in the dental practice and remotely
- No need for software licenses and maintenance. Utilize one subscription for any computer in the practice, at home or anywhere else

[Learn more >](#)

1. DS Core is not a medical device software. It is not intended to diagnose, treat, cure, or prevent any disease or health condition. Use only for information, education or sharing purposes. Service is subject to country availability. Please contact your local DS representative for more details.

Order at your lab with Connect Case Center

With Connect Case Center, our portal for collaboration, the process of ordering from your lab is simple and seamless. Primescan Connect is an open scanner, which means you can send data to any lab of your choice and they'll receive the information in the format they need.

Send data to your lab with just one click

- Connect Case Center allows you to transfer digital orders to dental labs within seconds – all compliant to HIPPA and GDPR
- Offers validated connectivity with all major lab software (inLab, 3Shape, exocad, etc.) so both you and your lab can continue working within existing workflows
- Review and discuss your cases digitally during the patient consultation
- Send additional data such as patient images and screenshots
- Connect Case Center Inbox license included free-of-charge for your lab, so they can easily start processing your scan data
- Access to validated workflows from Dentsply Sirona
 - SureSmile® aligners
 - Digital Implant Workflows via Simplant® and Atlantis®

99%

LAB ACCEPTANCE RATE of Dentsply Sirona scan data.¹

1. Internal unpublished data.

File-saving and sharing made easy

Your practice

Connect Case Center Digital Impression Primescan Connect Patient Media Library Practice account

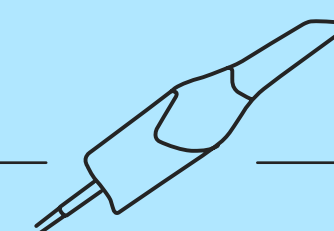
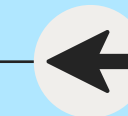

Automatic upload and storage



Order from your lab

Collaboration

Lab partners



Connect Case Center (Inbox web application)

Gateway to any lab software



Lab partners and colleagues



Their free account



View and add files



Comment on files

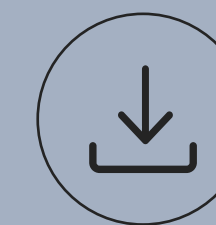

Download files



Expand into different workflows

From treatment of single units to more challenging cases, Primescan Connect supports you when you're performing every procedure. You can integrate it into your most requested dental treatments while also expanding your workflow possibilities, so you can grow your practice and offer an excellent patient experience.

Find out more about each workflow by clicking on the corresponding icon below.

Digitalize your workflows while keeping your established relationships. Your lab technician will appreciate the great scan results and easy data transfer for all restorative indications, as well as for all other application areas.

- Indirect restorations**
Crowns, inlays, onlays, bridges
- Implant restorations**
Abutments, screw-retained crowns
- Esthetics**
Veneers, smile makeovers



Restorative

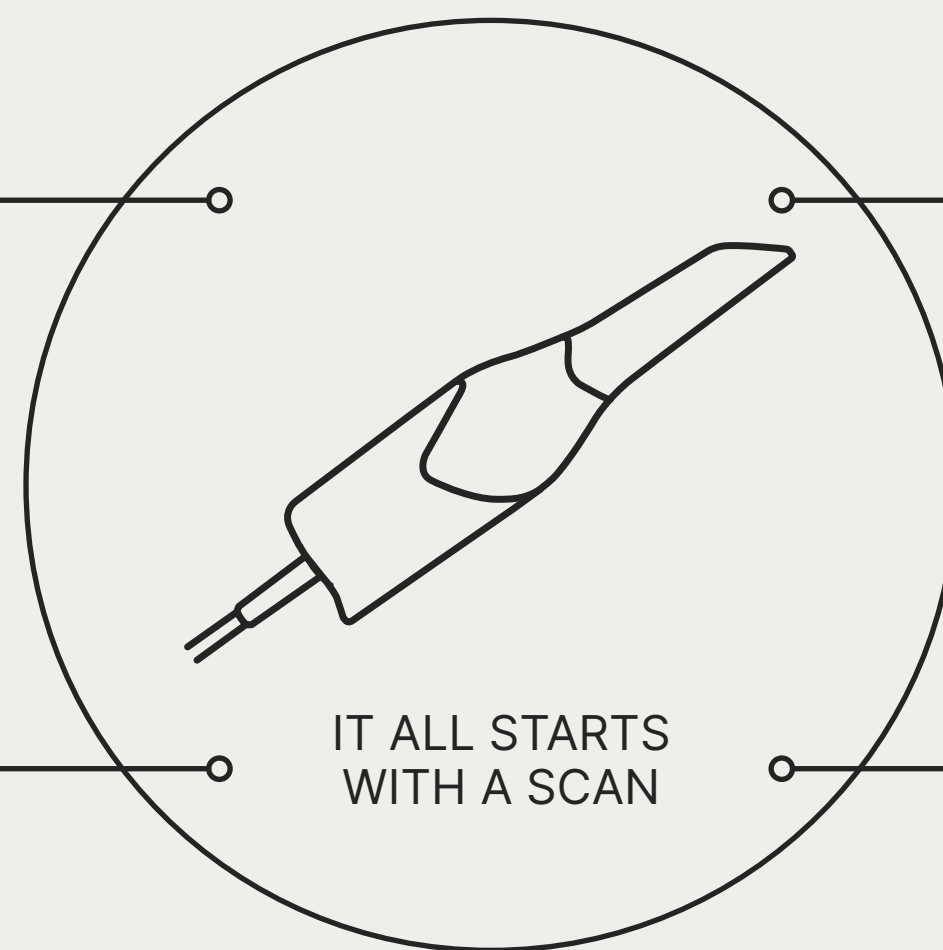

IT ALL STARTS WITH A SCAN

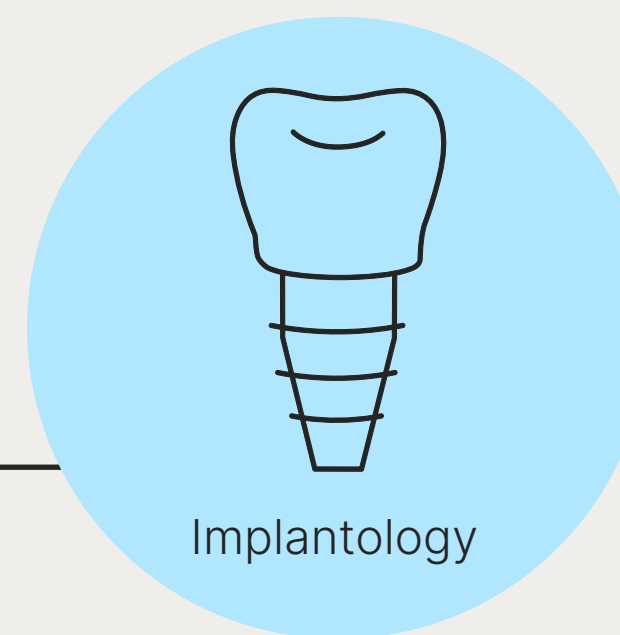

Implantology

- Implantology**
[DS PrimeTaper™](#)
Including a modern tapered implant, harmonized prosthetic options and a surgical and prosthetic kit
- Guided surgery**
Surgical guides with [Simplant](#)

Make use of various workflow options with Primescan Connect for both implant surgery and implant prosthetics. Directly connect to great partners such as [Simplant](#) and [Atlantis](#). Primescan Connect is now validated for Atlantis suprastructures.¹

Primescan Connect also opens the door to the digital world of orthodontics. Send data to your specialized partners to order orthodontic appliances, or take advantage of a seamless Dentsply Sirona workflow with SureSmile aligners for a quick and efficient treatment.

- Clear aligners**
[SureSmile](#) and other 3rd party providers



Orthodontics

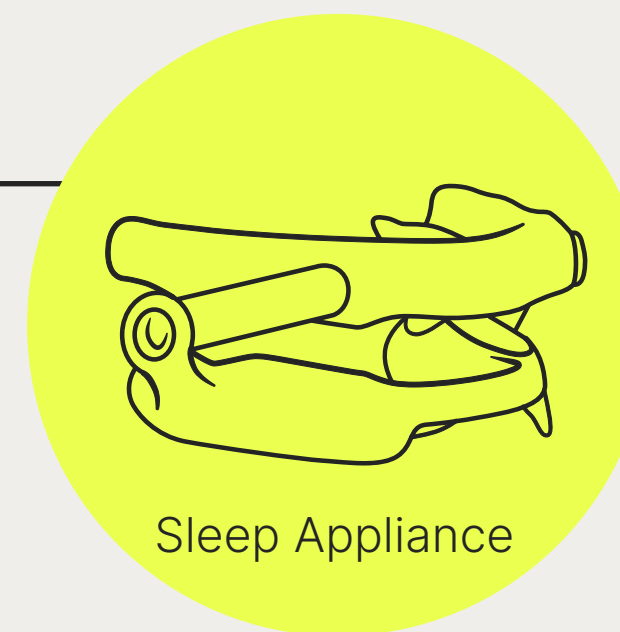

Sleep Appliance

- Sleep devices**
[Panthera Dental®](#)
Validated workflow to Panthera Sleep custom-made devices
- Splints**
(e.g., Night guards, jaw therapies)

Use Primescan Connect to expand your range of applications in the field of sleep appliances. Send the scan data to Panthera Sleep or your preferred partner to order high quality customized sleep devices and splints.

1. Full-arch fixed implant restorations based on Atlantis IO-FLO S scanbodies.



DS Core™ Care: run your practice with a high level of efficiency

Proactive and all-in-one comprehensive equipment service
DS Core Care can save you precious time, allowing you to concentrate on your patient's treatment. Get your peace of mind: DS Core Care keeps you covered with express intraoral scanner replacements in the case of unexpected incidents or even accidental damages.



Customer Support Portal

24/7 online product and workflow knowledge for immediate self-support



Hotline Support

Technical phone support from qualified service experts

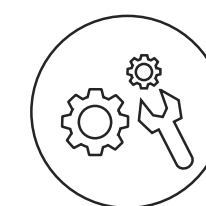

Fast Service Clarification

Share device information and technical status with your service technician for remote support via DS Core

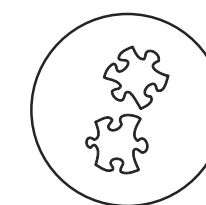

Spare Parts

Original manufacturer spare parts coverage for 3 years

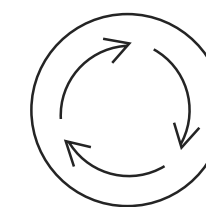

Replacement

Express equipment replacement program for Primescan Connect

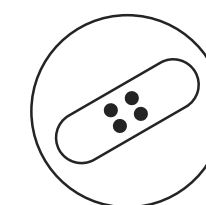

Accidental damage coverage

Extensive coverage of your intraoral scanner in case of unexpected incidents

The laptop is covered by Lenovo Premier Service. Please contact your local Denstply Sirona representative to confirm availability of DS Core Care in your country.



Take your first step into digital dentistry with confidence

With Primescan Connect, you can step into a digital world of possibilities. By connecting you with expert labs, streamlining your existing workflows and allowing you to easily integrate new procedures, Primescan Connect can help you run your practice more smoothly and grow with confidence.

Provide an excellent treatment experience

with the high-precision intraoral scanning technology of Primescan Connect

Collaborate seamlessly with lab partners and colleagues

with DS Core, the innovative cloud storage and file-sharing platform

Order at your lab of choice

with one click using Connect Case Center. As an open intraoral scanner, Primescan Connect gives you access to any lab software out there

Grow with Primescan Connect. Integrate it into your existing procedures and use it to expand into new digital workflows.

[Learn more >](#)



With Primescan Connect, you can focus on what matters most: treating your patients.



Digital Impression

High Performance

Collaboration

Workflows

Service & Support

Summary

Dentsply Sirona

Sirona Dental Systems GmbH
Fabrikstraße 31, 64625 Bensheim, Germany
dentsplysirona.com

Subject to technical changes and errors in the text, Order No. A91100-M43-C323-01-7600, 08/2022.

Registered trademarks, trade names and logos are used. Even if these are not identified as such in the respective places, the corresponding legal provisions apply.

Unless otherwise stated, all comparative statements in this document refer to a comparison of Dentsply Sirona products with each other.

THE DENTAL
SOLUTIONS
COMPANY™



Enjoy the scan with our latest technology

Primescan Connect completes a full arch scan in **less than 1 minute**, which means more comfort for your patients.

- Future-proof patented technology
- Easy scanning of deep cavities and steep inclines
- Simple scanning of large edentulous areas and palates
- Smooth scanning of reflective materials, like metal crowns, meaning no limitations in case selection
- Unique three sleeve concept and a variety of cleaning and disinfection options, exceeding the minimum recommended hygiene guidelines
- Fully closed scanning window to prevent liquid infiltration during the scanning process

Engineered for a very high level of performance

Faster and smoother scanning

The innovative **smart pixel sensor** processes more than 50,000 images per second, producing photorealistic and highly accurate data. By scanning at an incredible data density, Primescan Connect delivers complete 3D structures of everything in its field of view – from the very first scan.

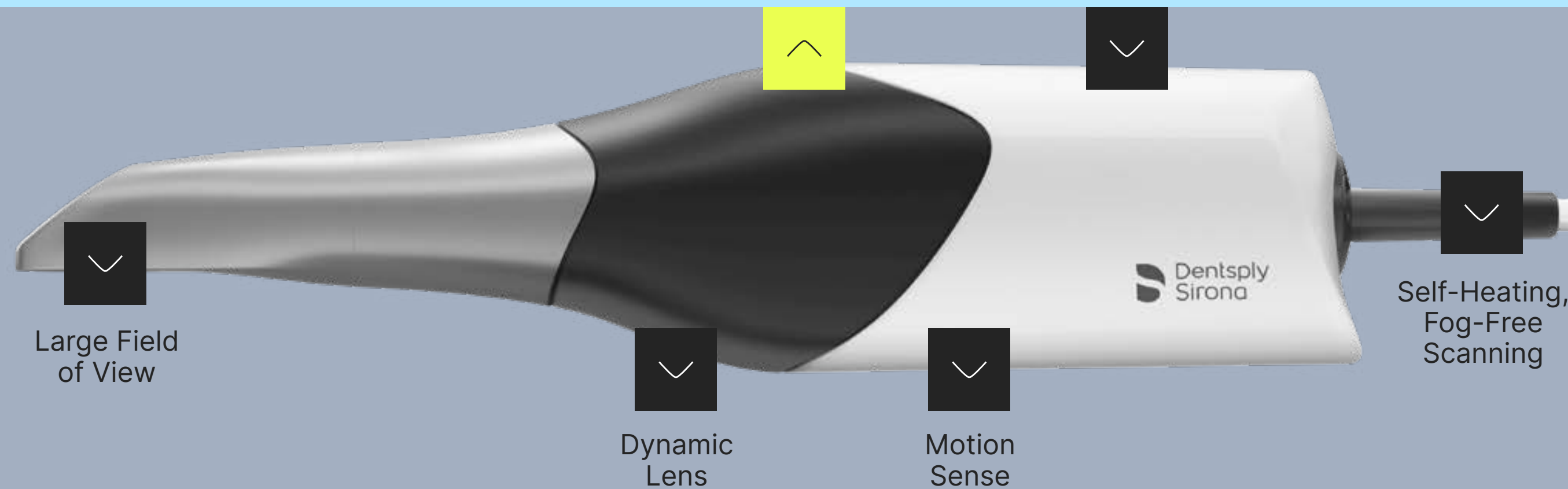

With three different sleeves, you can easily integrate the intraoral scanner into your hygiene concept

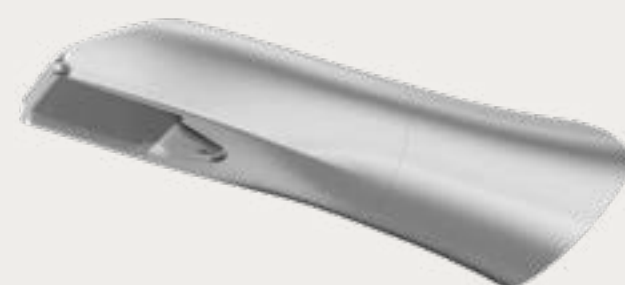

Autoclavable steel sleeve with single-use window.



Disposable sleeve meeting hygiene requirements to prevent cross-contamination.



Steel sleeve with sapphire glass window that can be sterilized with dry heat or treated with high-level disinfection (HLD).

Enjoy the scan with our latest technology

Primescan Connect completes a full arch scan in **less than 1 minute**, which means more comfort for your patients.

- Future-proof patented technology
- Easy scanning of deep cavities and steep inclines
- Simple scanning of large edentulous areas and palates
- Smooth scanning of reflective materials, like metal crowns, meaning no limitations in case selection
- Unique three sleeve concept and a variety of cleaning and disinfection options, exceeding the minimum recommended hygiene guidelines
- Fully closed scanning window to prevent liquid infiltration during the scanning process

Engineered for a very high level of performance

Faster calculation and fewer interruptions

Intelligent Processing enables seamless collaboration with the software by transmitting all the data needed to proceed. Real-time artifact removal is automatically performed while scanning to keep the model clean.

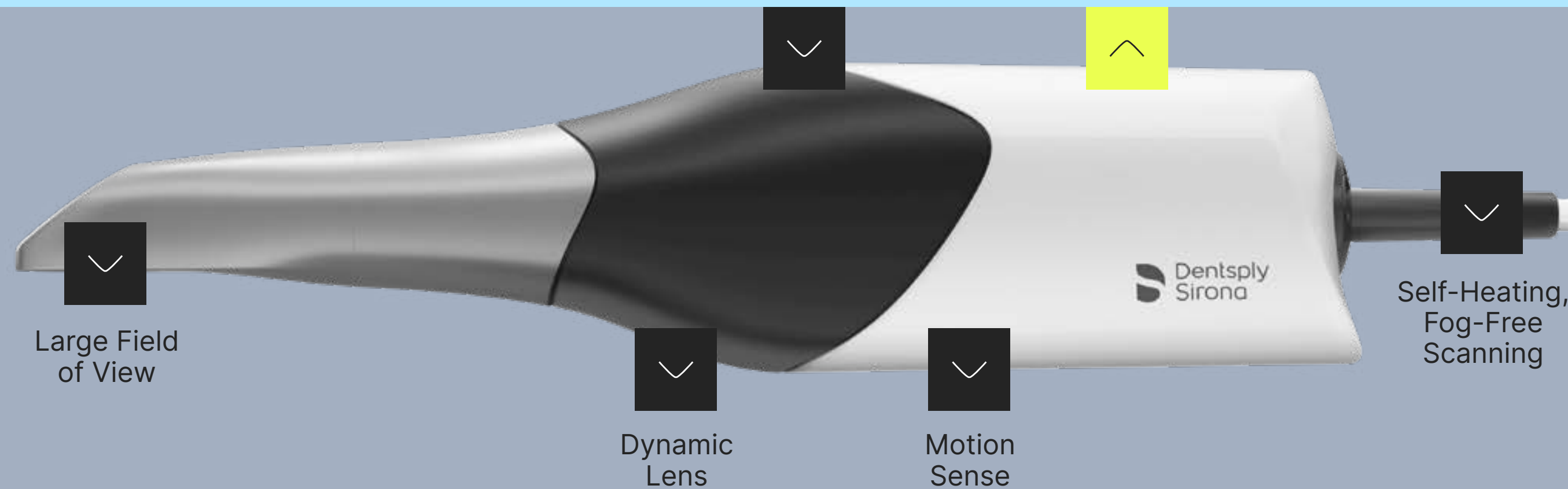

With three different sleeves, you can easily integrate the intraoral scanner into your hygiene concept

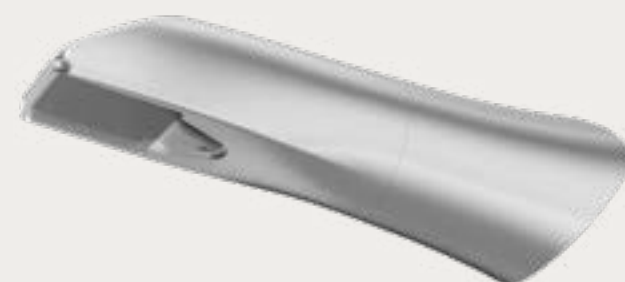

Autoclavable steel sleeve with single-use window.



Disposable sleeve meeting hygiene requirements to prevent cross-contamination.



Steel sleeve with sapphire glass window that can be sterilized with dry heat or treated with high-level disinfection (HLD).

Enjoy the scan with our latest technology

Primescan Connect completes a full arch scan in **less than 1 minute**, which means more comfort for your patients.

- Future-proof patented technology
- Easy scanning of deep cavities and steep inclines
- Simple scanning of large edentulous areas and palates
- Smooth scanning of reflective materials, like metal crowns, meaning no limitations in case selection
- Unique three sleeve concept and a variety of cleaning and disinfection options, exceeding the minimum recommended hygiene guidelines
- Fully closed scanning window to prevent liquid infiltration during the scanning process

Engineered for a very high level of performance



Click on the device feature to learn more

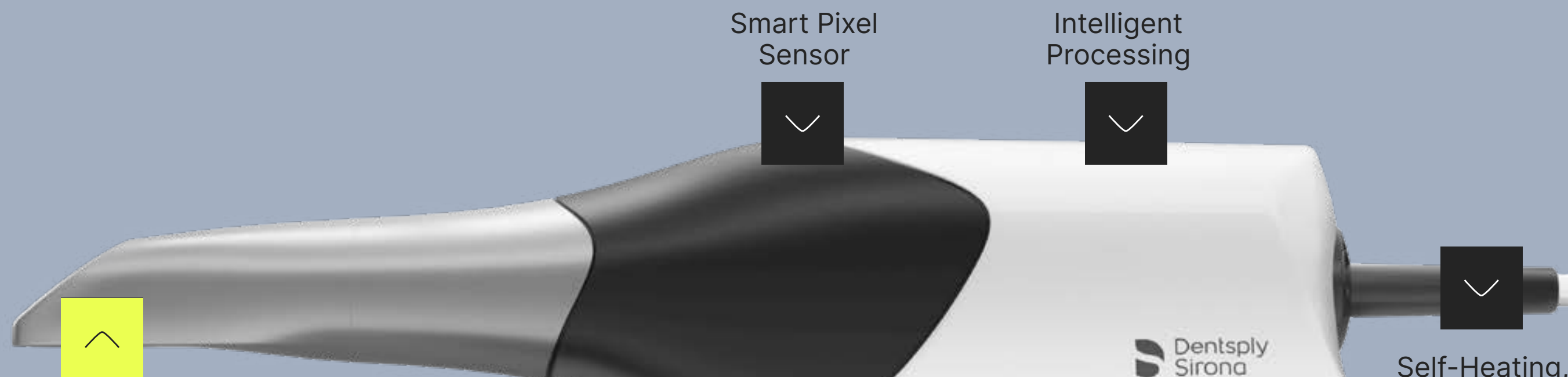

You get what you need

Primescan Connect's **large field of view** captures everything that is within its view. Its dynamic depth scan technology enables excellent sharpness and precision even at a measuring depth up to 20mm – a crucial advantage for subgingival indications. The automatic artifact removal cuts out extraneous data such as a cheek, tongue or finger in real time during a scan.

With three different sleeves, you can easily integrate the intraoral scanner into your hygiene concept



Autoclavable steel sleeve with single-use window.



Disposable sleeve meeting hygiene requirements to prevent cross-contamination.

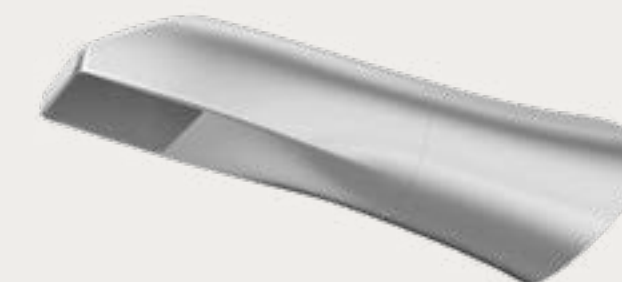

Steel sleeve with sapphire glass window that can be sterilized with dry heat or treated with high-level disinfection (HLD).

Enjoy the scan with our latest technology

Primescan Connect completes a full arch scan in **less than 1 minute**, which means more comfort for your patients.

- Future-proof patented technology
- Easy scanning of deep cavities and steep inclines
- Simple scanning of large edentulous areas and palates
- Smooth scanning of reflective materials, like metal crowns, meaning no limitations in case selection
- Unique three sleeve concept and a variety of cleaning and disinfection options, exceeding the minimum recommended hygiene guidelines
- Fully closed scanning window to prevent liquid infiltration during the scanning process

Engineered for a very high level of performance



Click on the device feature to learn more

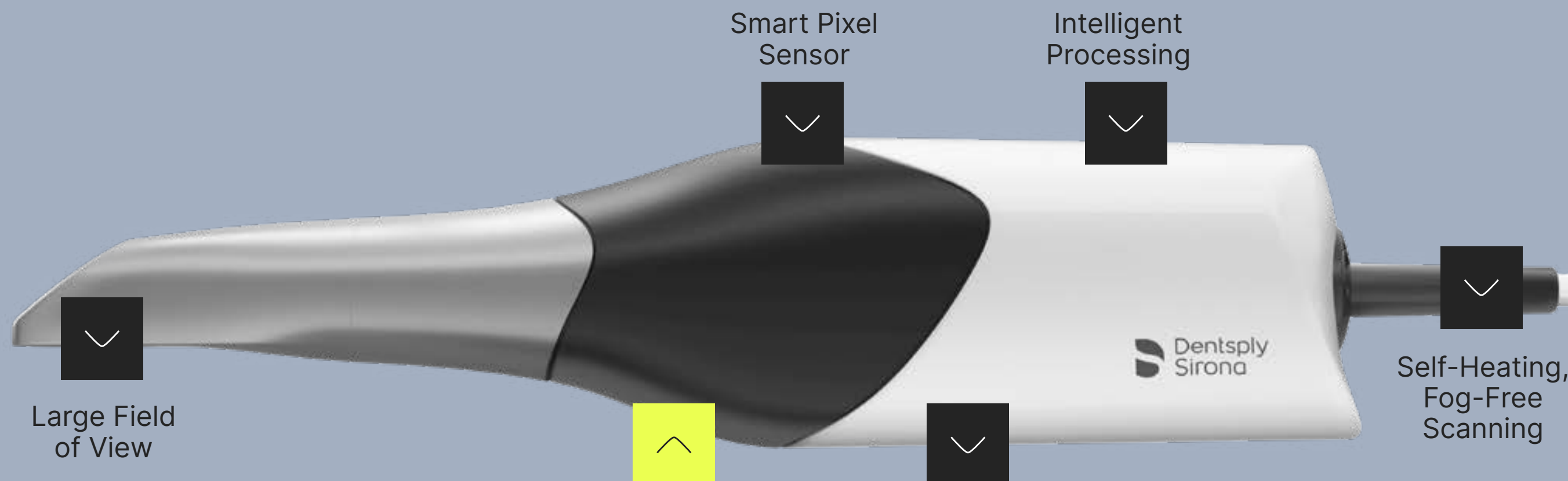

Dynamic Lens

It supports you when you're capturing difficult-to-reach areas.

With three different sleeves, you can easily integrate the intraoral scanner into your hygiene concept

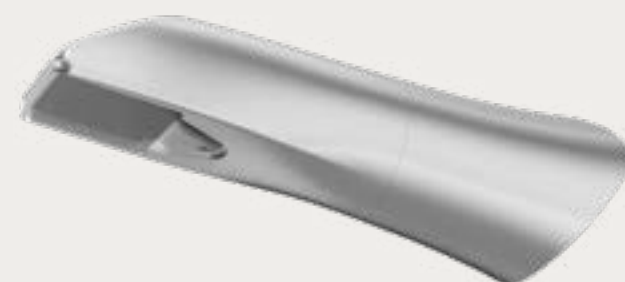

Autoclavable steel sleeve with single-use window.



Disposable sleeve meeting hygiene requirements to prevent cross-contamination.



Steel sleeve with sapphire glass window that can be sterilized with dry heat or treated with high-level disinfection (HLD).

Enjoy the scan with our latest technology

Primescan Connect completes a full arch scan in **less than 1 minute**, which means more comfort for your patients.

- Future-proof patented technology
- Easy scanning of deep cavities and steep inclines
- Simple scanning of large edentulous areas and palates
- Smooth scanning of reflective materials, like metal crowns, meaning no limitations in case selection
- Unique three sleeve concept and a variety of cleaning and disinfection options, exceeding the minimum recommended hygiene guidelines
- Fully closed scanning window to prevent liquid infiltration during the scanning process

Engineered for a very high level of performance



Click on the device feature to learn more

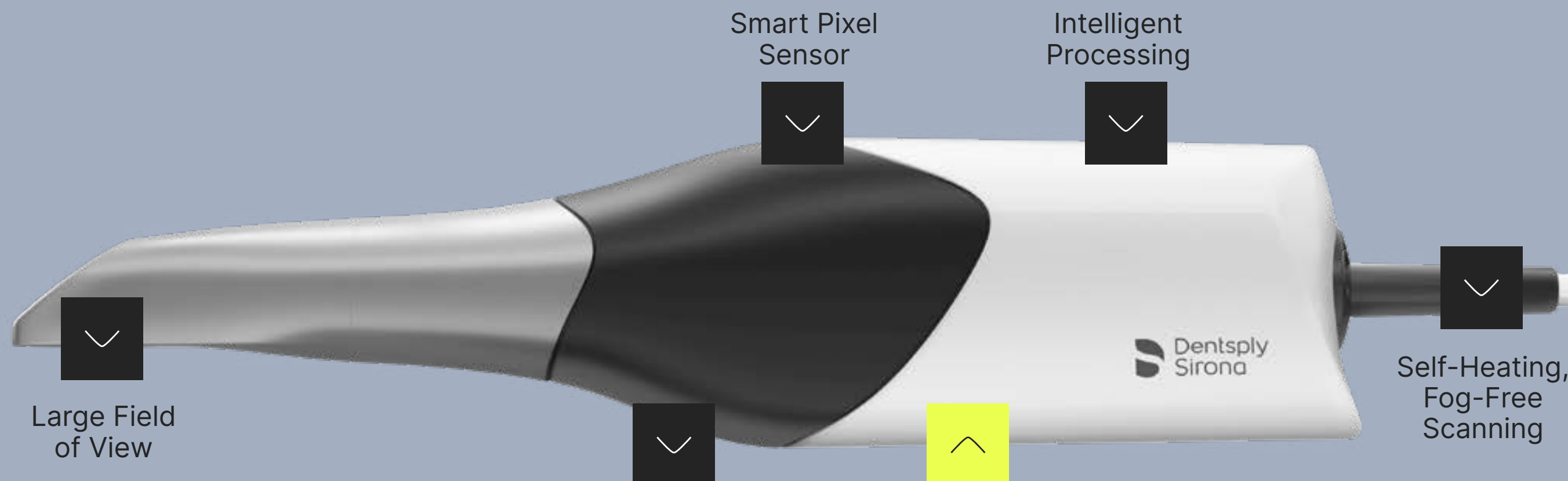

Motion Sense

The scanner is switched on automatically when removed from its cradle. Scanning can start less than 1 second after automatic activation.

With three different sleeves, you can easily integrate the intraoral scanner into your hygiene concept

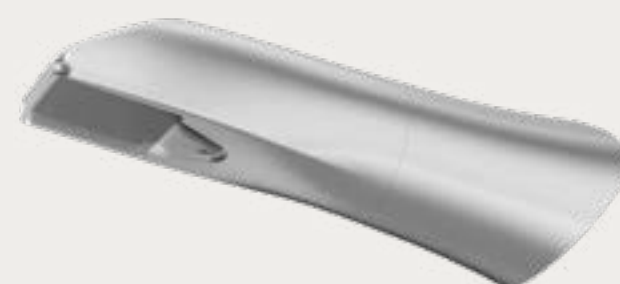

Autoclavable steel sleeve with single-use window.



Disposable sleeve meeting hygiene requirements to prevent cross-contamination.



Steel sleeve with sapphire glass window that can be sterilized with dry heat or treated with high-level disinfection (HLD).

Enjoy the scan with our latest technology

Primescan Connect completes a full arch scan in **less than 1 minute**, which means more comfort for your patients.

- Future-proof patented technology
- Easy scanning of deep cavities and steep inclines
- Simple scanning of large edentulous areas and palates
- Smooth scanning of reflective materials, like metal crowns, meaning no limitations in case selection
- Unique three sleeve concept and a variety of cleaning and disinfection options, exceeding the minimum recommended hygiene guidelines
- Fully closed scanning window to prevent liquid infiltration during the scanning process

Engineered for a very high level of performance



Click on the device feature to learn more

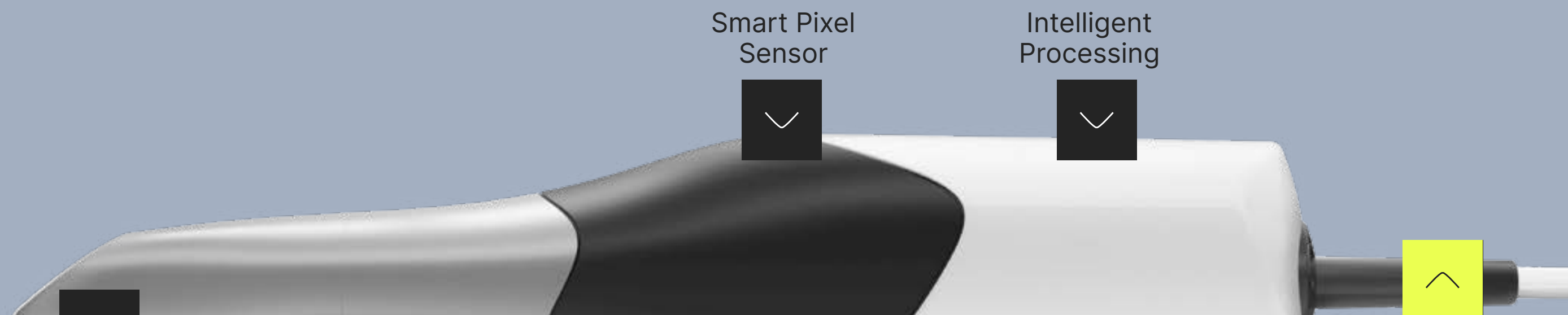

Start scanning right away

Primescan Connect offers continuous **self-heating, fog-free scanning** – which means you are always ready to scan.

With three different sleeves, you can easily integrate the intraoral scanner into your hygiene concept



Autoclavable steel sleeve with single-use window.



Disposable sleeve meeting hygiene requirements to prevent cross-contamination.



Steel sleeve with sapphire glass window that can be sterilized with dry heat or treated with high-level disinfection (HLD).